

FLUME DOUBLE WALL LIGHT (US WIRED)

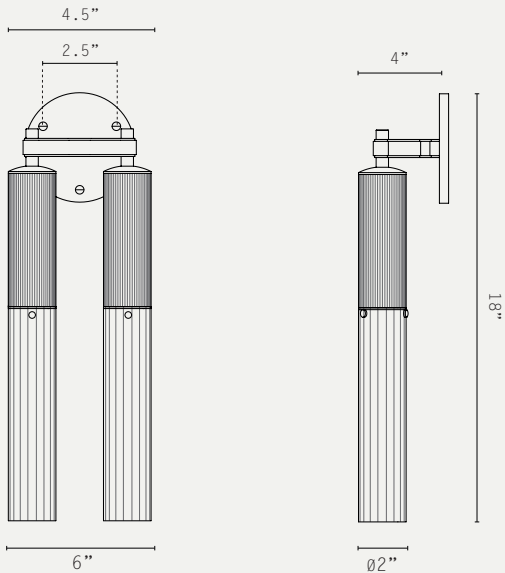

LIGHT SOURCE:

GU10 LAMP BASE (4W MAX, LED)
1.4" MAX DIAMETER

LAMP SUPPLIED:

2 X GU10 MR11 / 3000K / 4W /
250 LUMENS

DIMMABLE:

PHASE DIMMING (USING SUPPLIED
LAMP)

VOLTAGE:

120V AC

CERTIFICATIONS:

UL / cUL



MATERIALS:

BRASS, GLASS

WEIGHT:

6.5 LB (APPROX)





OPTIONAL ACCESSORIES:

- DEEP MOUNTING BACKBOX



ADDITIONAL INFO:

SUPPLIED WITH ADAPTOR DISC FOR
4" JUNCTION BOX
DESIGNED BY WILL EARL 2019
MADE IN ENGLAND

METAL FINISHES:

-  ANTIQUE BRASS
-  BRONZE
-  SATIN BRASS
-  SATIN NICKEL

GLASS OPTIONS:

-  CLEAR REEDED GLASS
-  FROSTED REEDED GLASS

PRODUCT CODES:

U.FL.DW.AB.CRG - ANTIQUE BRASS / CLEAR REEDED GLASS
U.FL.DW.BZ.CRG - BRONZE / CLEAR REEDED GLASS
U.FL.DW.SB.CRG - SATIN BRASS / CLEAR REEDED GLASS
U.FL.DW.SN.CRG - SATIN NICKEL / CLEAR REEDED GLASS

U.FL.DW.AB.FRG - ANTIQUE BRASS / FROSTED REEDED GLASS
U.FL.DW.BZ.FRG - BRONZE / FROSTED REEDED GLASS
U.FL.DW.SB.FRG - SATIN BRASS / FROSTED REEDED GLASS
U.FL.DW.SN.FRG - SATIN NICKEL / FROSTED REEDED GLASS