

STRATA 3200 PENDANT



LIGHT SOURCE:

LINEAR 24V LED MODULE / 2700K
90W / 11050 LUMENS

DIMMING:

PHASE (MAINS) DIMMING USING
SUPPLIED 2 X 24V DRIVER

VOLTAGE:

24V D.C (DRIVER LOCATED IN
EACH CEILING CANOPY)

CERTIFICATIONS:

CE / UKCA

MATERIALS:

BRASS, GLASS

WEIGHT:

26 KG (APPROX)

OPTIONAL ACCESSORIES:

DALI DRIVER
0-10V DRIVER

SUSPENSION:

DROP ROD AT 100MM INCREMENTS



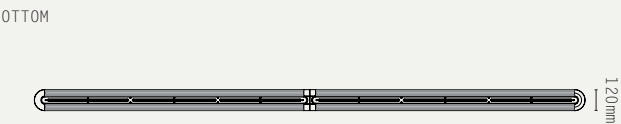
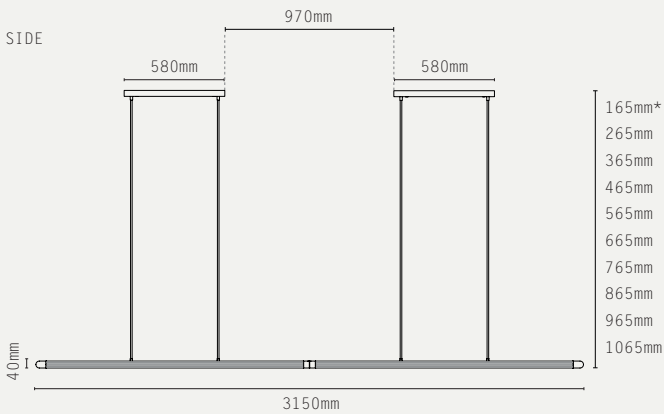

ADDITIONAL INFO:

DESIGNED BY WILL EARL 2024
MADE IN ENGLAND



*choose total drop - longer drop available at extra cost

METAL FINISHES:

-  ANTIQUE BRASS
-  BRONZE
-  SATIN BRASS
-  SATIN NICKEL

GLASS OPTIONS:

-  CLEAR REEDED GLASS

PRODUCT CODES:

- STR.P32.AB.CRG - ANTIQUE BRASS / CLEAR REEDED GLASS
- STR.P32.BZ.CRG - BRONZE / CLEAR REEDED GLASS
- STR.P32.SB.CRG - SATIN BRASS / CLEAR REEDED GLASS
- STR.P32.SN.CRG - SATIN NICKEL / CLEAR REEDED GLASS